

Schematic :

PC BOARD CONNECTIONS

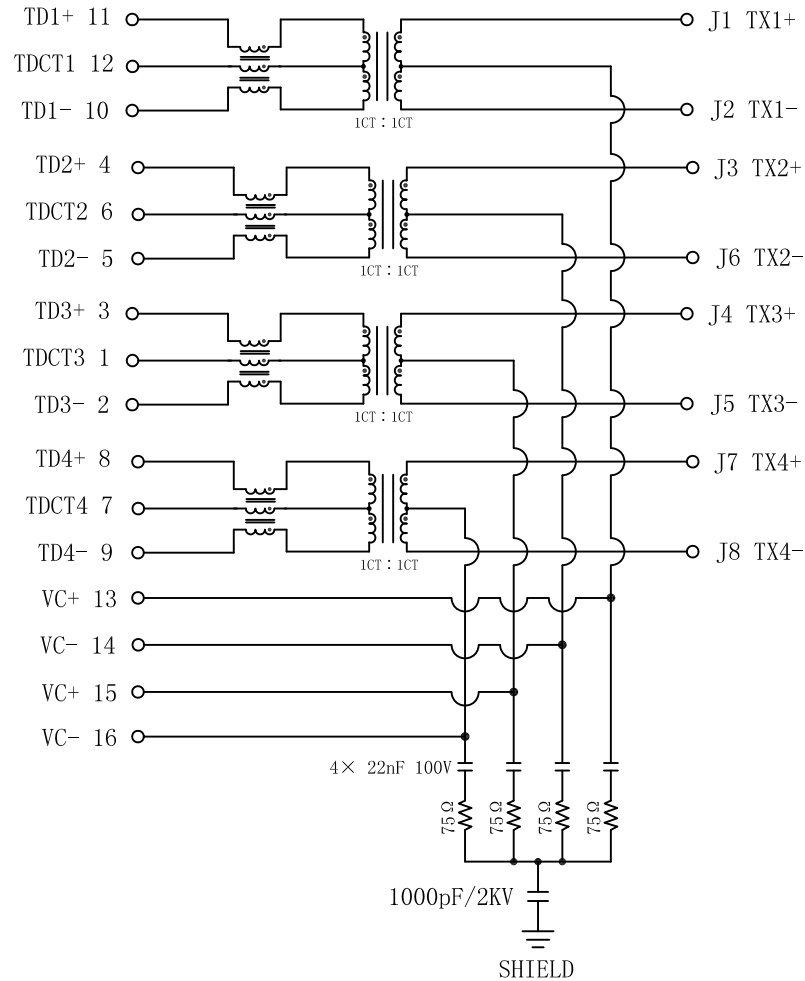

RJ45 CONNECTOR

REV.	ECN NO.	DESCRIPTION	DATE	APPD
A	REL		2020-08-17	

Electronical Specifications:

- 1.0 Turn Ratio @100KHz: (P11~P10):(J1~J2) = 1:1±5%
(P4~P5):(J3~J6) = 1:1±5%
(P3~P2):(J4~J5) = 1:1±5%
(P8~P9):(J7~J8) = 1:1±5%
- 2.0 Primary Inductance: 350uH MIN @100KHZ,0.1V 8mA DC BIAS
120uH MIN @100KHZ,0.1V 19mA DC BIAS
- 3.0 DC Resistance: 1.2 OHMS MAX
- 4.0 Insertion Loss: 1-100MHz -1.0dB MAX
100-125MHz -1.2dB MAX
- 5.0 Return Loss: 1-40MHz -16dB MIN
40-60MHz -12dB MIN
60-80MHz -10dB MIN
80-100MHz -8dB MIN
- 6.0 CROSS TALK: 1-100MHz -30dB MIN
- 7.0 COMMON TO COMMON MODE ATTENUATION: 1-100MHz -30dB MIN
- 8.0 Isolation: PHY Side to Line Side: 2250VDC
- 9.0 DC CURRENT/VOLTAGE RATING-PSE PINS: 720mA MAX @57VDC (CONTINUOUS)
- 10.0 Meets IEEE802.3at

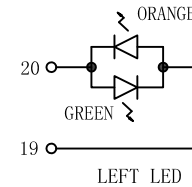

LEFT LED

LED POLARITY		COLOR
PIN 20	PIN 19	
+	-	GREEN
-	+	ORANGE

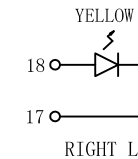

RIGHT LED

LED POLARITY		COLOR
PIN 18	PIN 17	
+	-	YELLOW

Emitting Color	λp(nm)	VF@F=20mA	IR @VR=5V
ORANGE / GREEN	610 / 565	1.8~2.6V	10 μA max
YELLOW	585	1.8~2.6V	10 μA max



X:X ±0.30	APPD:	LINK-PP INT'L TECHNOLOGY CO., LIMITED
X:XX ±0.25	CHKD:	
X:XXX ±0.05	DR: TOM	TITLE: RJ45 Connector with 1000 Base-T Integrated Magnetics For PoE+ Application
ANGLES ±1°	UNIT: mm	PART NO.: LPJK46051AONL
	SCALE: 2/1	SHEET: 1/2
	REV: A	DWG NO.: LP20081701

Mechanical :

REV.	ECN NO.	DESCRIPTION	DATE	APPD
A	REL		2020-08-17	

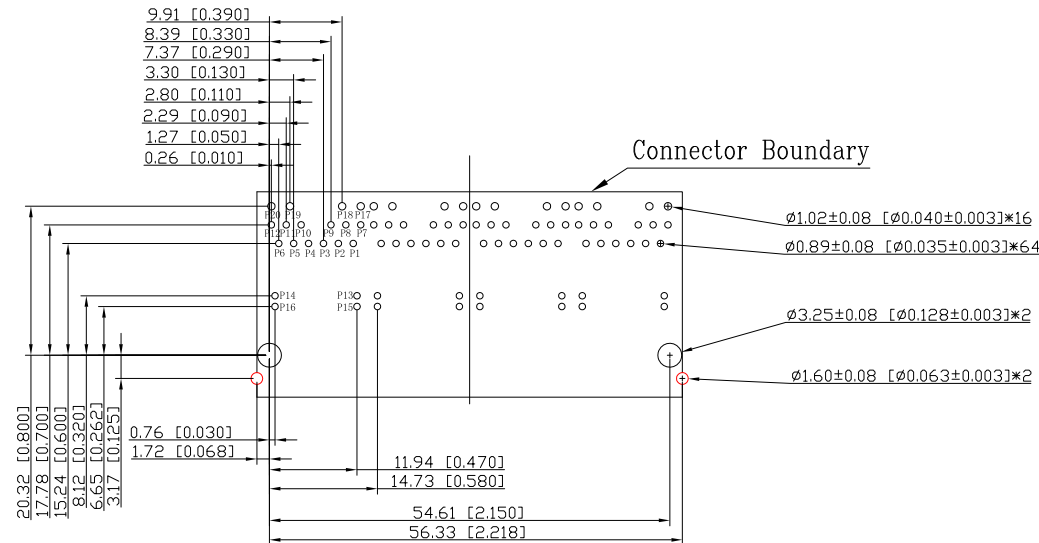
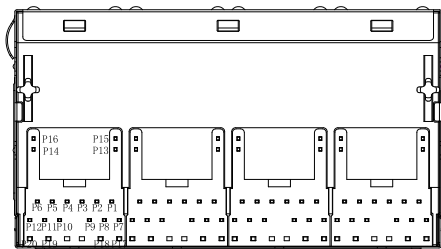
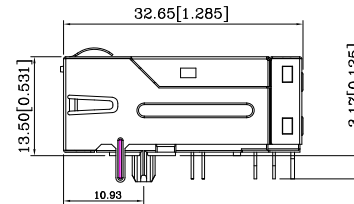
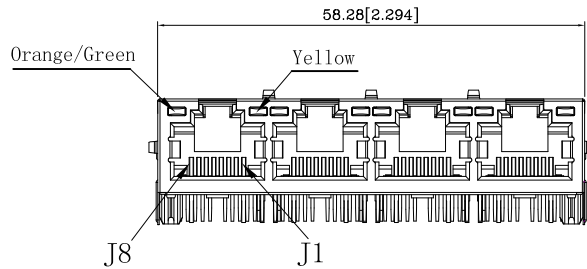

NOTES:

1. Designed to support application, such as SOHO (ADSL modems), LAN-ON-Motherboard (LOM), hub and Switches.
2. Meets IEEE 802.3at specification
3. Connector Materials:
 Housing Material: Thermoplastic PBT+30%G.F UL94V-0
 Contact Material: Phosphor Bronze C5210R-EH Thickness=0.35mm
 Pins: Brass C2680R-H Thickness=0.35mm
 Shield: Copper alloy Brass H65Y Thickness=0.2mm
 Contact plating: Gold 6 micro-inches min. In contact area.
4. Wave solder tip temperature: 265°C Max, 5 Sec.
5. UL Certification: File Number E484635.

X:X	±0.30	APPD:	LINK-PP INT'L TECHNOLOGY CO., LIMITED
X:XX	±0.25	CHKD:	
X:XXX	±0.05	DR: TOM	TITLE: RJ45 Connector with 1000 Base-T Integrated Magnetics For PoE+ Application
ANGLES	±1°	UNIT: mm	PART NO.: LPJK46051AONL
	SCALE: 2/1	SHEET: 2/2	REV: A DWG NO.: LP20081701