

Schematic:

REV.	ECN NO.	DESCRIPTION	DATE	APPD
A6	REL		2023-03-16	

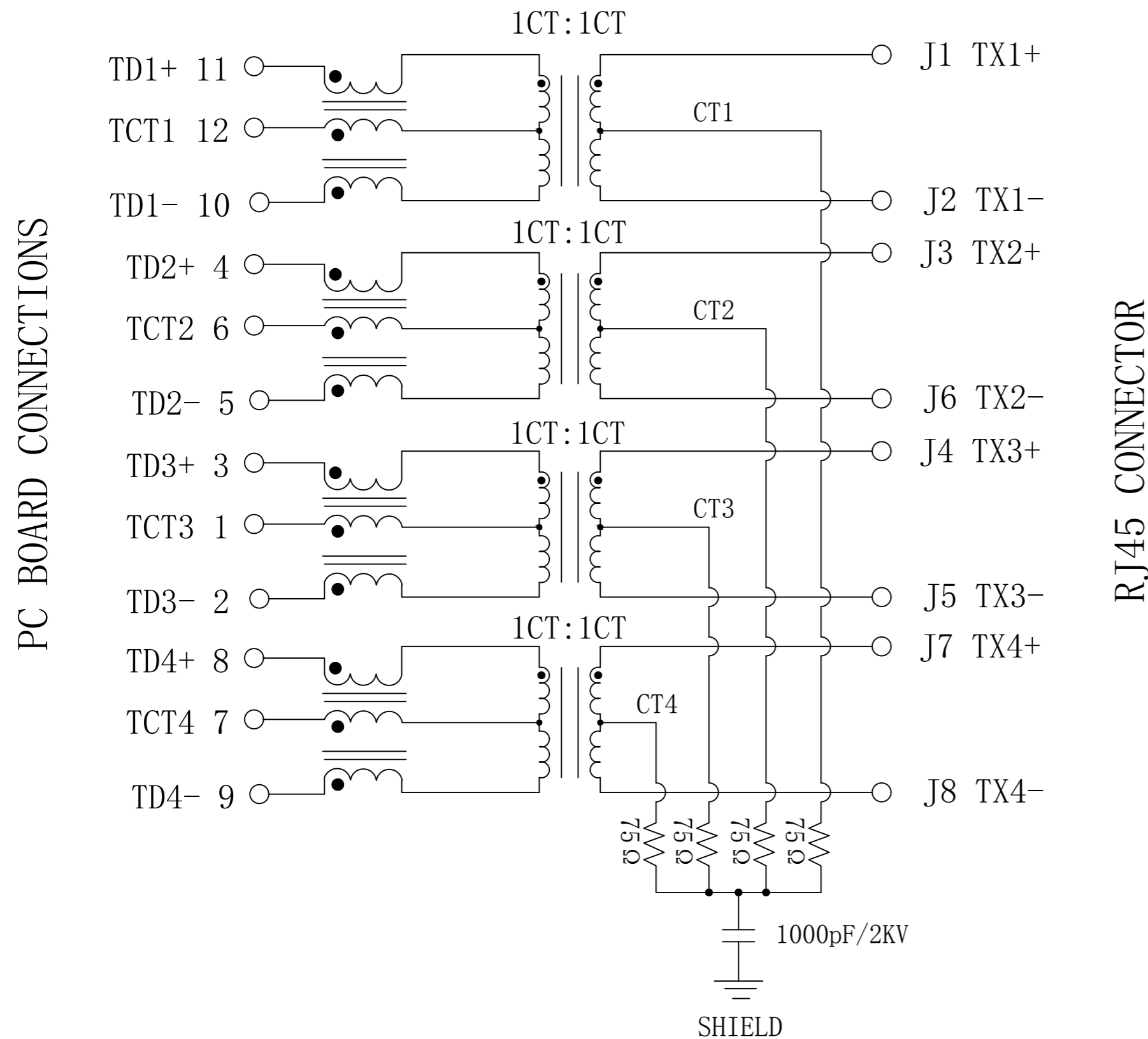

Electrical Specifications @25°C

- Turns Ratio($\pm 2\%$):
Pri : Sec = 1CT : 1CT
- OCL(@100KHz, 100mV, 8mA DC Bias):
350uH Min
- Insertion Loss:
1~100MHz:-1.0dB Max
- Return Loss(dB Min):
1~10MHz:-20 ; 30MHz:-16
60~80MHz:-12 ; 80~100MHz:-10
- Crosstalk(dB Min):
1~10MHz:-40 ; 32~65MHz:-35
65~100MHz:-30
- Common Mode Rejection(dB Min):
1~100MHz:-30
- Isolation PHY SIDE To Line SIDE : 1500Vrms
- Operating Temperature: -40°C ~ +85°C.

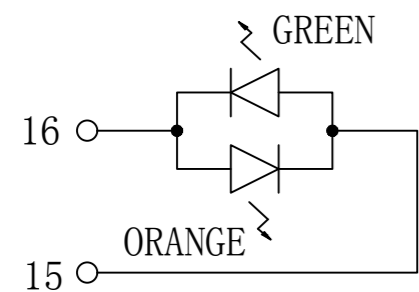

LEFT LED

LED POLARITY		COLOR
PIN 16	PIN 15	
+	-	ORANGE
-	+	GREEN

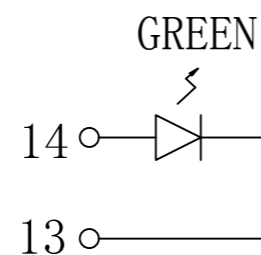

RIGHT LED

LED POLARITY		COLOR
PIN 14	PIN 13	
+	-	GREEN

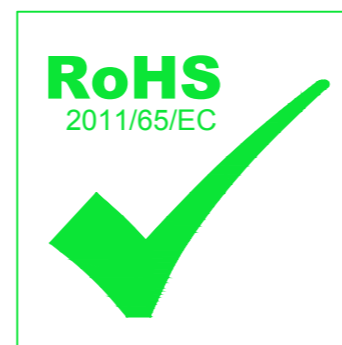

Emitting Color	λ_p (nm)	V _F @I _F =20mA	I _R @V _R =5V
GREEN	565	1.8~2.6V	10 μ A max
ORANGE	610	1.8~2.6V	10 μ A max

X:X ± 0.30	APPD: TOM	LINK-PP INT'L TECHNOLOGY CO., LIMITED	
X:XX ± 0.25	CHKD: JAMES	TITLE: RJ45 Connector with 1000 Base-T Integrated Magnetics	
X:XXX ± 0.05	DR: LEO	PART NO.: LPJK4036AYNL	
ANGLES $\pm 1^\circ$	UNIT: mm	DWG NO.: LP23031662	
	SCALE: 2/1	SHEET: 1/2	REV: A6

Mechanical :

REV.	ECN NO.	DESCRIPTION	DATE	APPD
A6	REL		2023-03-16	

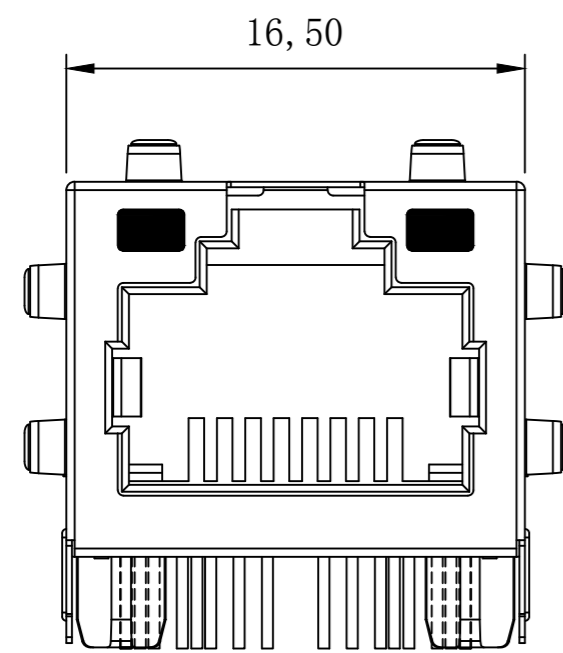

Front Side View

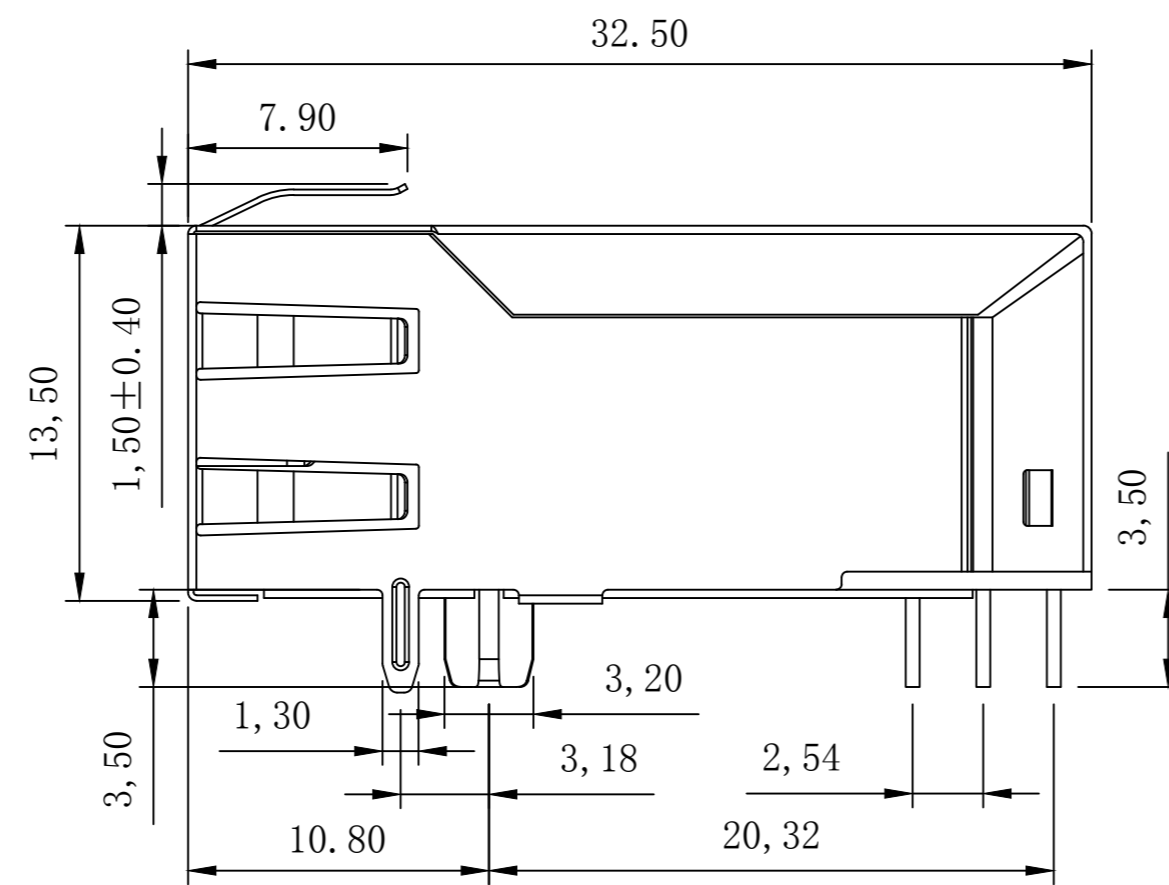

Left Side View

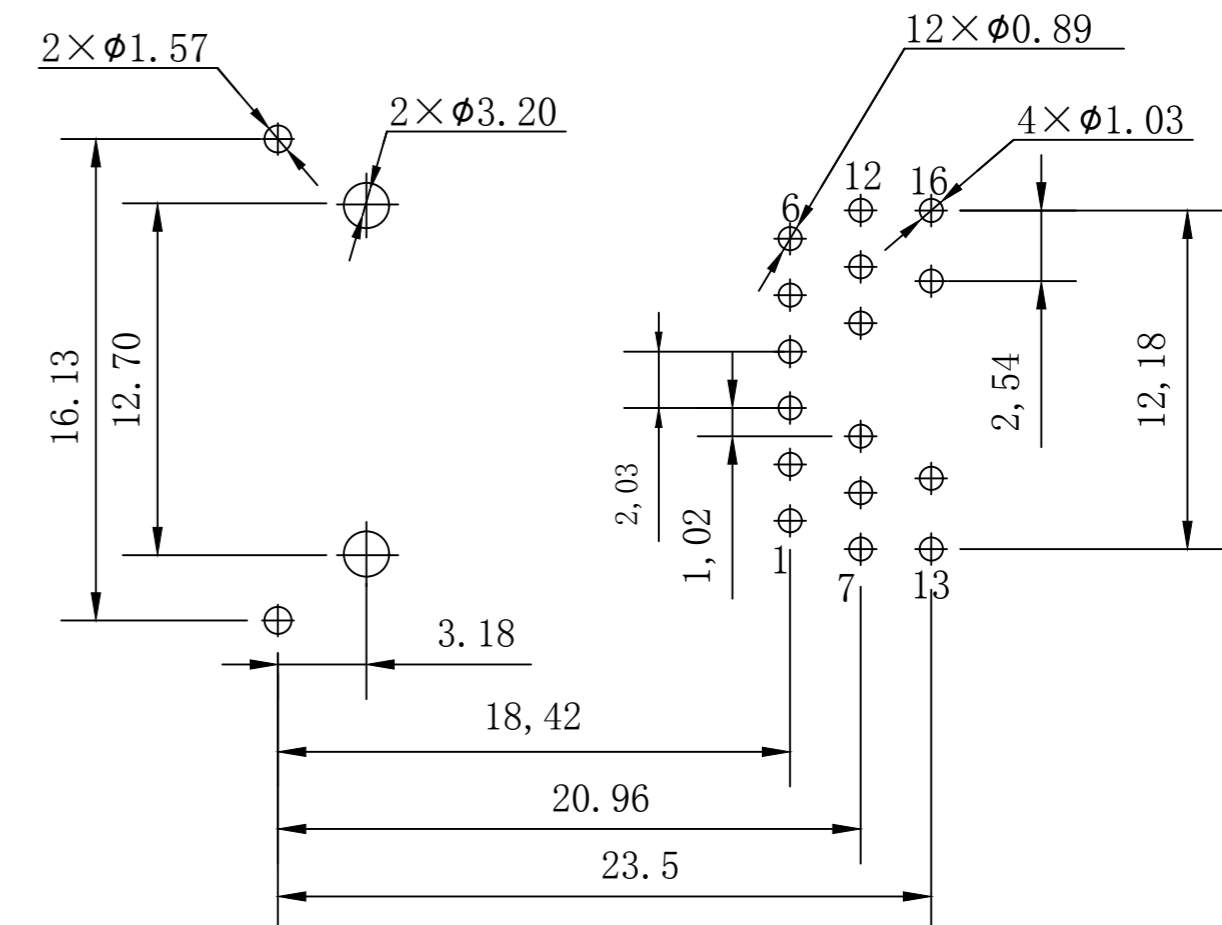

Suggested PCB Layout (Top View)

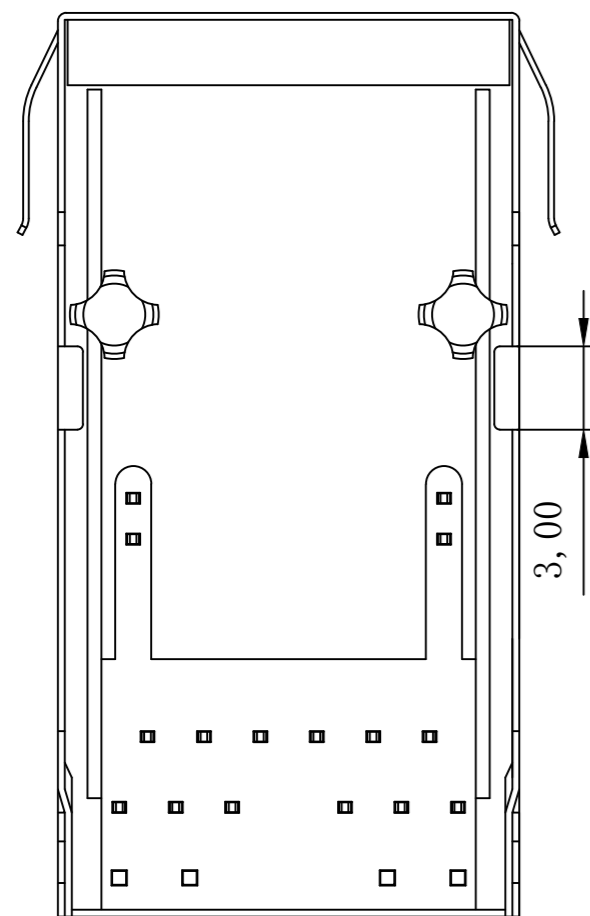

Bottom Side View

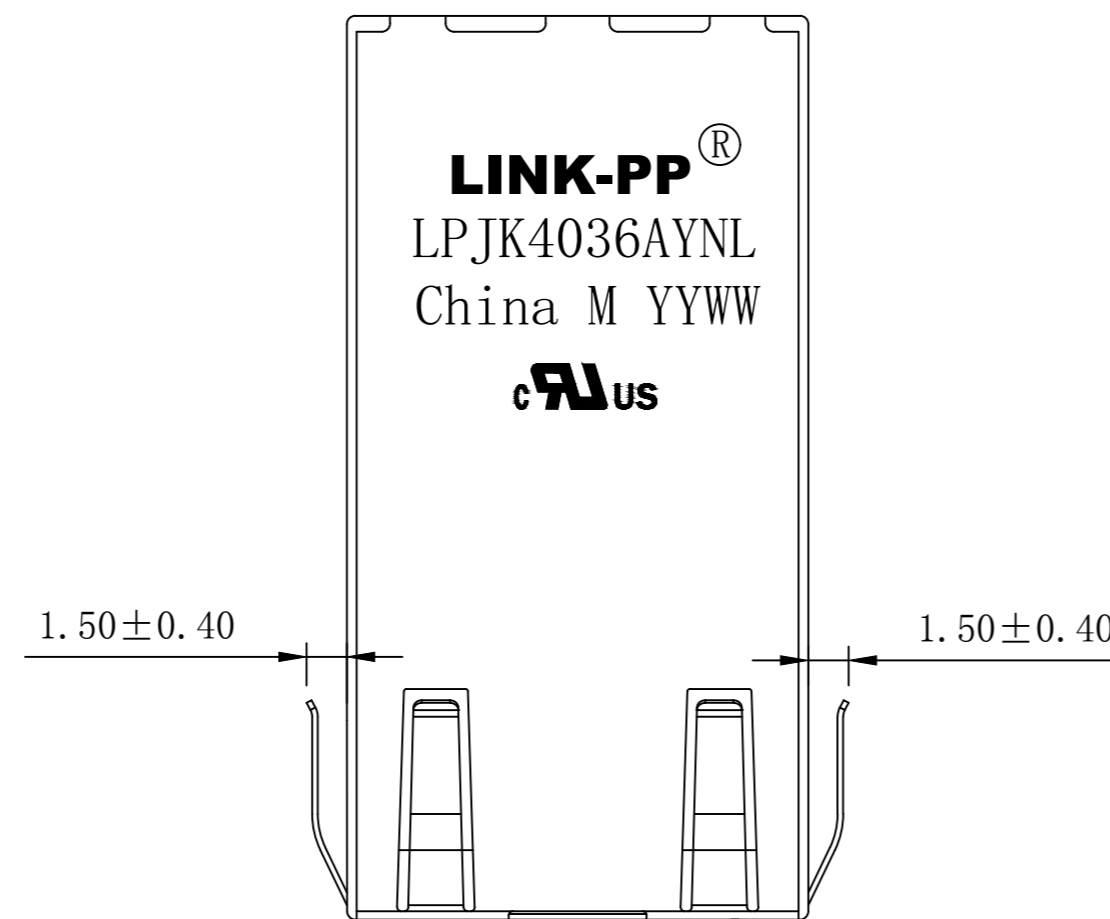

Top Side View

NOTES:

1. Designed to support application, such as SOHO (ADSL modems), LAN-on-Motherboard (LOM), hub and Switches.
2. Meets IEEE 802.3 specification
3. Connector Materials:
 Housing Material: Thermoplastic PBT+30%G. F UL94V-0
 Contact Material: Phosphor Bronze C5210R-EH Thickness=0.35mm
 Pins: Brass C2680R-H Thickness=0.35mm
 Shield: SUS 304 1/2EH Thickness=0.2mm
 Contact plating: Gold 6 micro-inches min. In contact area.
4. Wave solder tip temperature: 250°C, 5 Sec.
5. UL Certification: File Number E484635.



X:X ±0.30	APPD: TOM	LINK-PP INT'L TECHNOLOGY CO., LIMITED
X:XX ±0.25	CHKD: JAMES	
X:XXX ±0.05	DR: LEO	TITLE: RJ45 Connector with 1000 Base-T Integrated Magnetics
ANGLES ±1°	UNIT: mm	PART NO.: LPJK4036AYNL
	SCALE: 2/1	SHEET: 2/2
	REV: A6	DWG NO.: LP23031662