

Schematic:

REV.	ECN NO.	DESCRIPTION	DATE	APPD
A	REL		2011/06/29	

PC BOARD CONNECTIONS

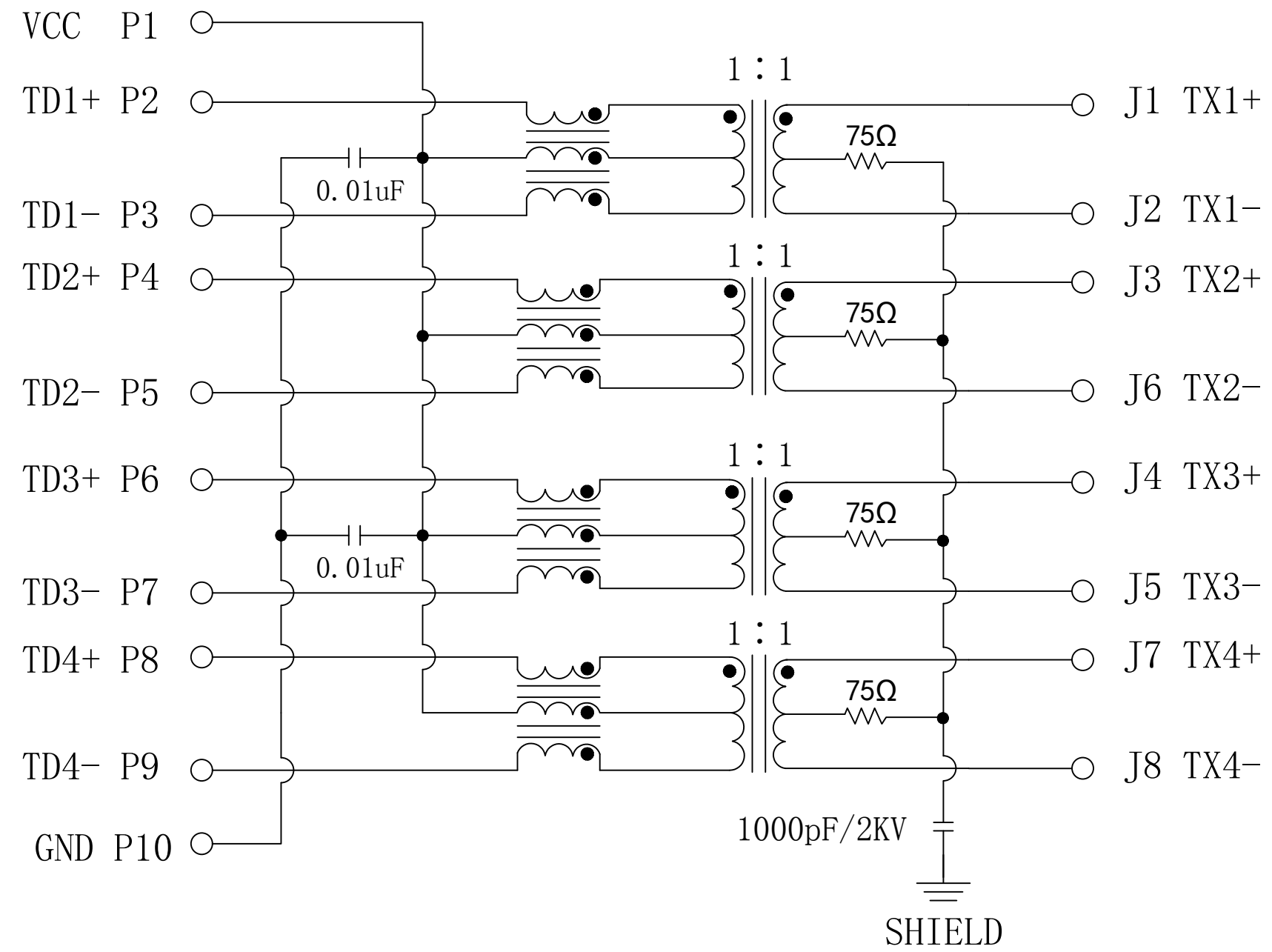

RJ45 CONNECTOR

Electrical Specifications @25°C

- Impedance: 100 ohms
- OCL: 350uH Min
@100KHz, 0.1V, 8mADC BIAS
- Turns Ratio: 1 : 1 ±3%
- Insertion Loss:
1-100MHz:-1.1dB Max
- Return Loss(dB Min):
1-40MHz:-18 60MHz:-14
80MHz:-12 100MHz:-10
- Crosstalk:
1-100MHz:-35dB Typ
- Common Mode Rejection(dB Typ):
0.1-30MHz:-38 30-60MHz:-35
60-100MHz:-30
- Isolation PHY SIDE To Line SIDE : 1500Vrms
- Operating Temperature: 0°C ~ 70°C.

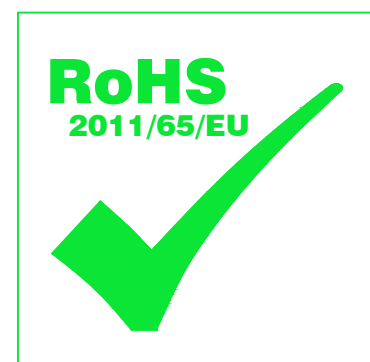

X:X ±0.30	APPD: TOM	LINK-PP INT'L TECHNOLOGY CO., LIMITED		
X:XX ±0.25	CHKD: JAMES			
X:XXX ±0.05	DR: LEO			
ANGLES ±1°	UNIT: mm	TITLE: RJ45 Connector with 1000 BASE-TX Integrated Magnetic		
		PART NO.: LPJG26873-8CNL		
	SCALE: 2/1	SHEET: 1/2	REV: A	DWG NO.: LP11062918

Mechanical:

REV.	ECN NO.	DESCRIPTION	DATE	APPD
A	REL		2011/06/29	

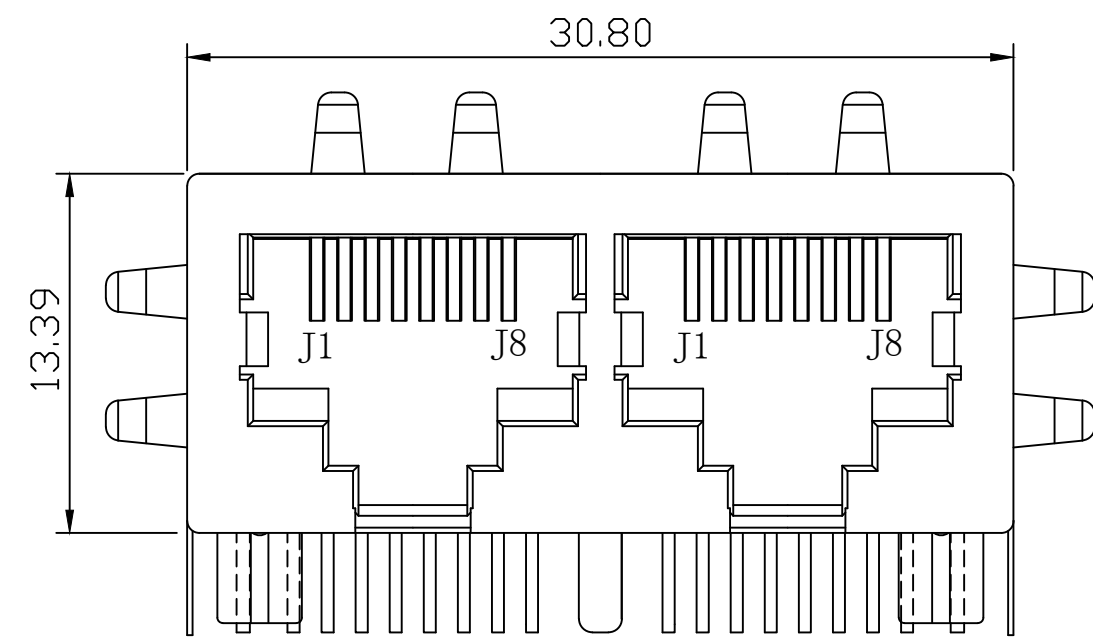

Front Side View

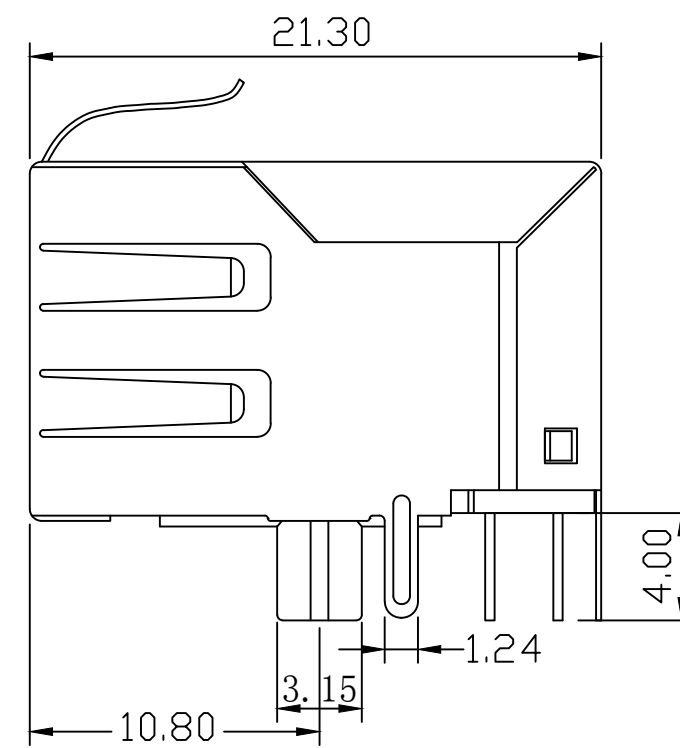

Left Side View

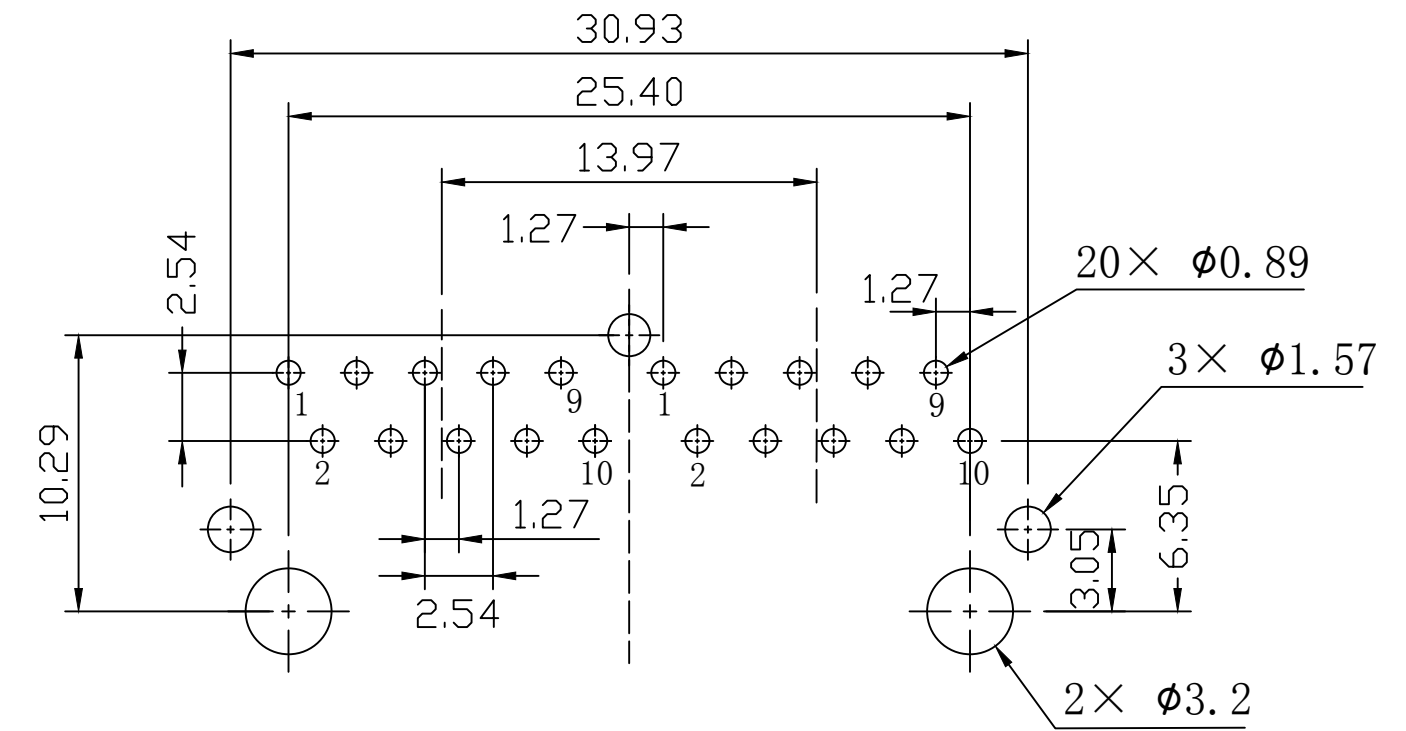

Suggested PCB Layout (Top View)

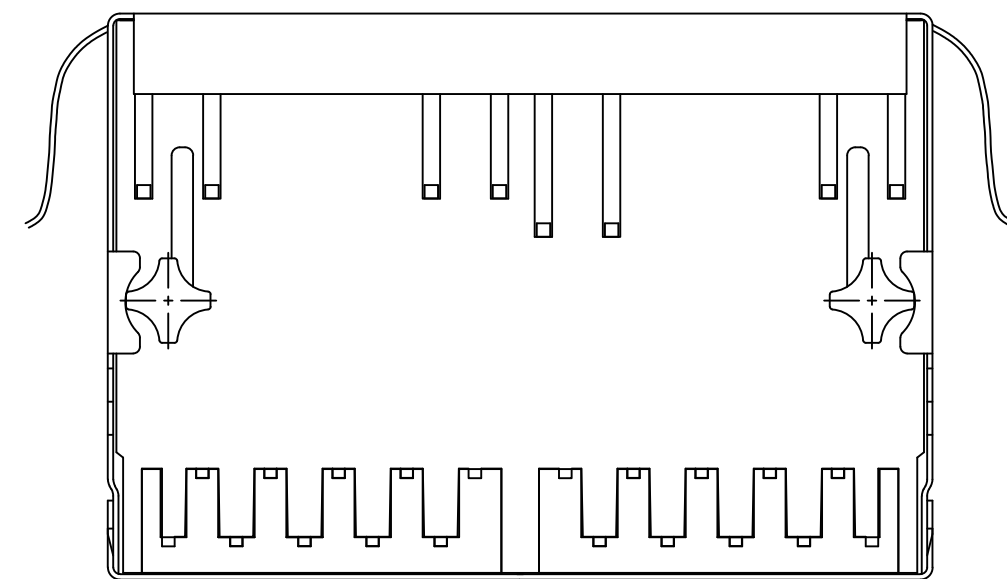

Bottom View

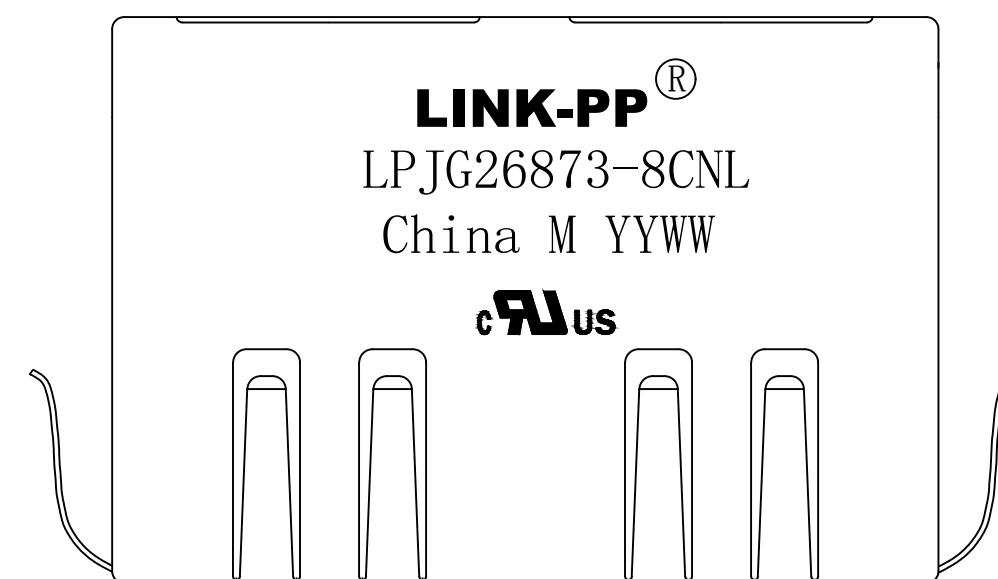

Top Side View

NOTES:

1. Designed to support application, such as SOHO (ADSL modems), LAN-on-Motherboard (LOM), hub and Switches.
2. Meets IEEE802.3 specification.
3. Connector Materials:
 Housing: Thermoplastic PBT+30%G.F UL94V-0
 Contact: Phosphor Bronze C5210R-EH Thickness=0.35mm
 Pins: Brass C2680R-H Thickness=0.35mm
 Shield: SUS 304-1/2H Thickness=0.2mm
 Contact plating: Gold 30 micro-inches min. In contact area.
4. Wave solder tip temperature: 250°C, 5 Sec.
5. UL Certification: File Number E484635.



X:X ±0.30	APPD: TOM	LINK-PP INT'L TECHNOLOGY CO., LIMITED
X:XX ±0.25	CHKD: JAMES	
X:XXX ±0.05	DR: LEO	TITLE: RJ45 Connector with 1000 BASE-TX Integrated Magnetic
ANGLES ±1°	UNIT: mm	PART NO.: LPJG26873-8CNL
	SCALE: 2/1	SHEET: 2/2
	REV: A	DWG NO.: LP11062918