

Schematic:

REV.	ECN NO.	DESCRIPTION	DATE	APPD
A	REL		17/07/2008	

PC BOARD CONNECTIONS

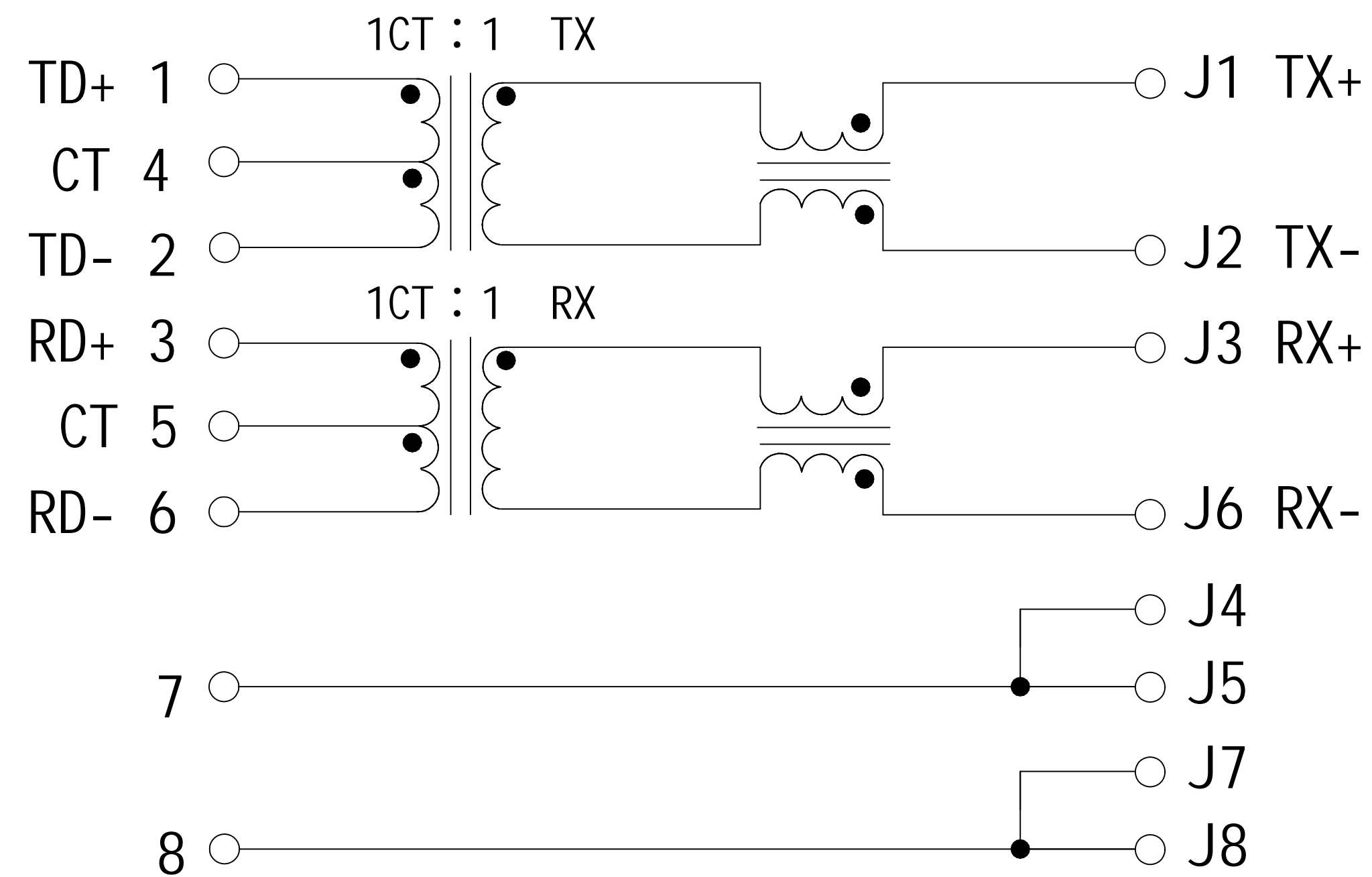

RJ45 CONNECTOR

ELECTRICAL SPECIFICATIONS: @25°C

- Turn Ratio:
TX=1CT : 1 RX=1CT : 1
- Inductance OCL: 350uH MIN
@100KHz 0.1V 8mA DC Bias
- Insertion Loss:
-1.0dB MAX @1~65MHz
- Return Loss:
-20dB MIN @1~10MHz
-16dB MIN @10~30MHz
-12dB MIN @30~60MHz
-10dB MIN @60~100MHz
- Cross talk:
-40dB MIN @1~30MHz
-35dB MIN @30~60MHz
-30dB MIN @60~100MHz
- Common Mode Rejection:
-30dB MIN @1~50MHz
-20dB MIN @50~150MHz
- Hipot: 1500Vrms @60Hz 1 MIN
- Operating Temperature Range: 0°C~70°C.

Emitting Color	λ_p (nm)	V _F @I _F =20mA	I _R @V _R =5V
GREEN	565	1.8~2.6V	10 μ A max
YELLOW	585	1.8~2.6V	10 μ A max

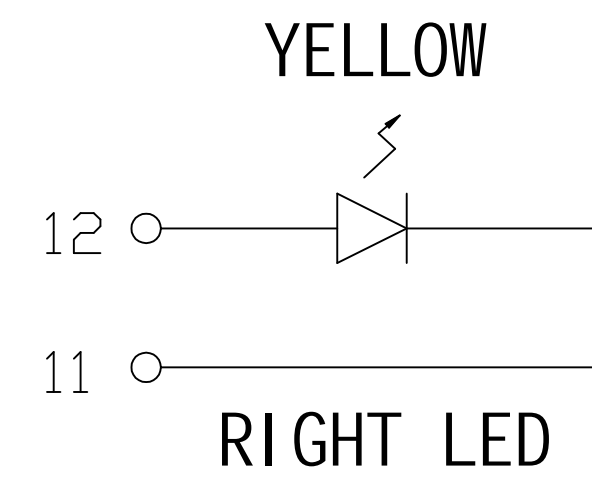
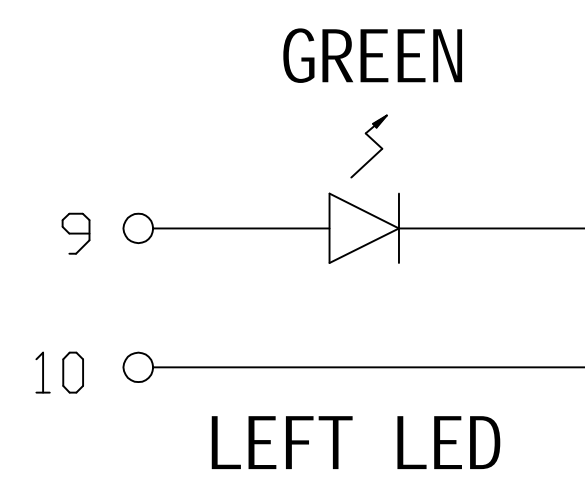
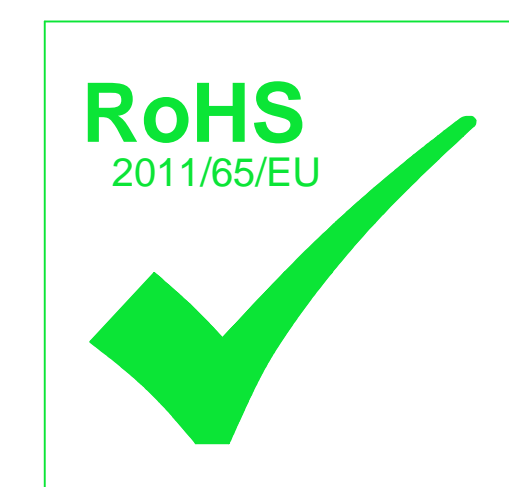

X: X ± 0.30	APPD:	LINK-PP INT'L TECHNOLOGY CO., LIMITED
X: XX ± 0.25	CHKD:	
X: XXX ± 0.05	DR: TOM	TITLE: RJ45 Connector with 10/100 Base-T Integrated Magnetics
ANGLES $\pm 1^\circ$	UNIT: mm	PART NO.: LPJ0006BBNL
	SCALE: 2/1	SHEET: 1/2
	REV: A	DWG NO.: LP08121246

Mechanical :

REV.	ECN NO.	DESCRIPTION	DATE	APPD
A	REL		12/12/2008	

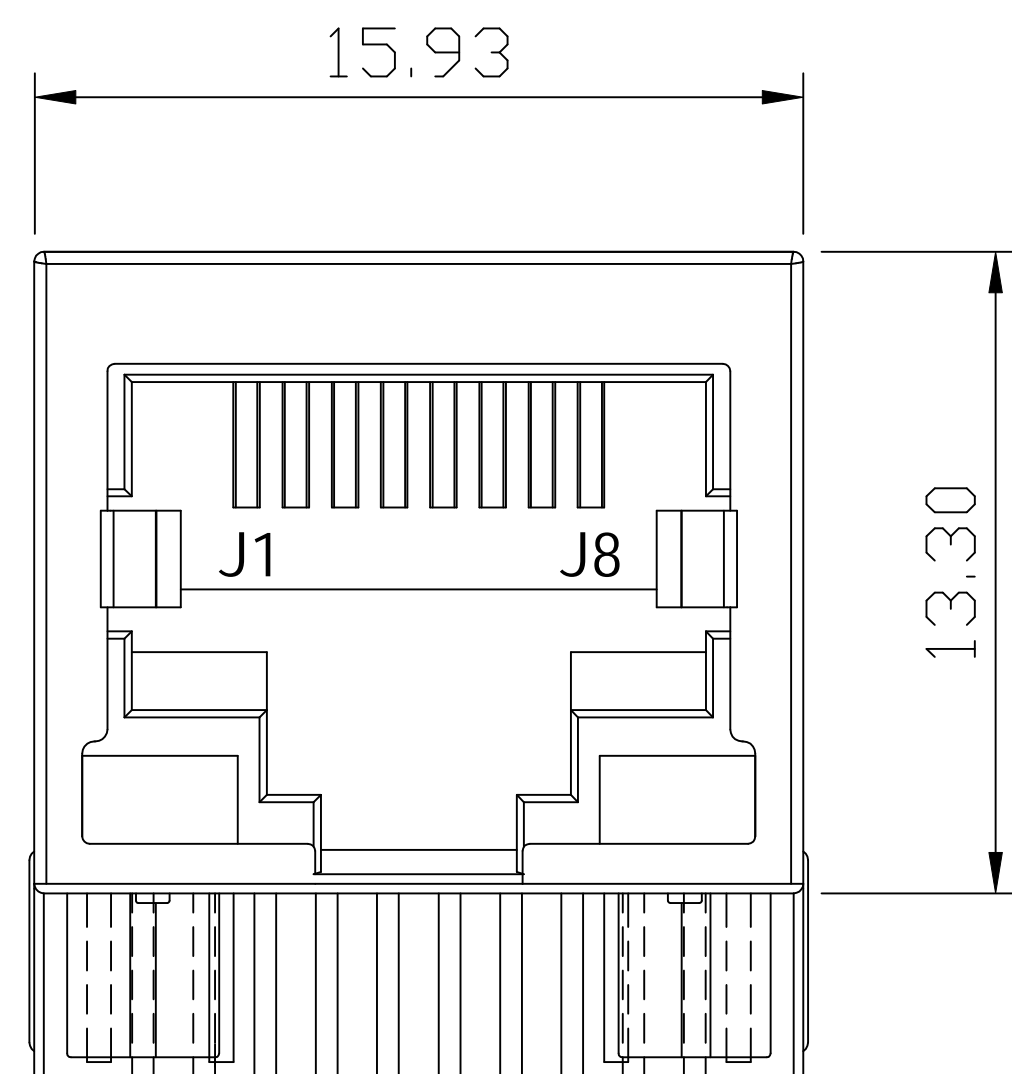

Front Side View

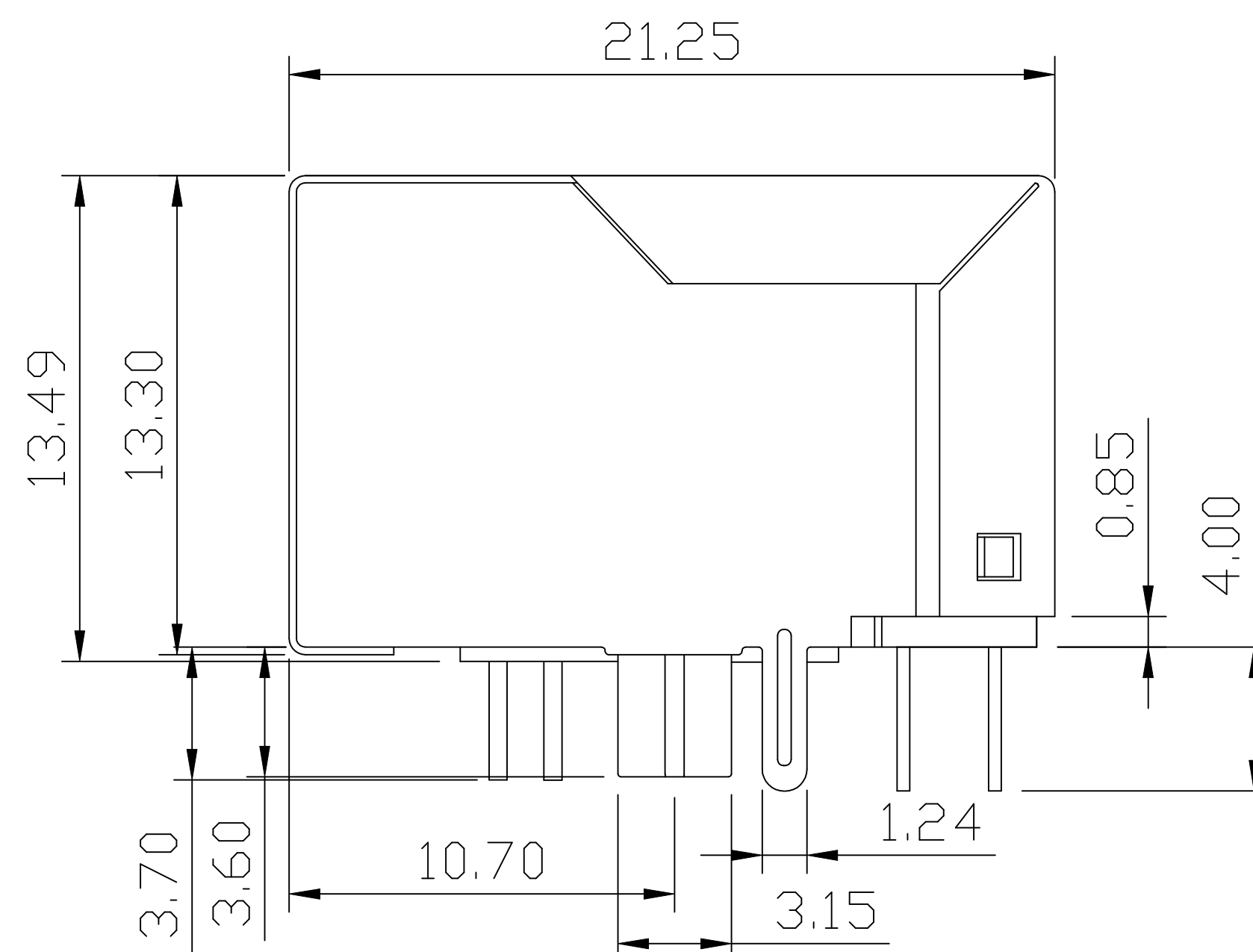

Left Side View

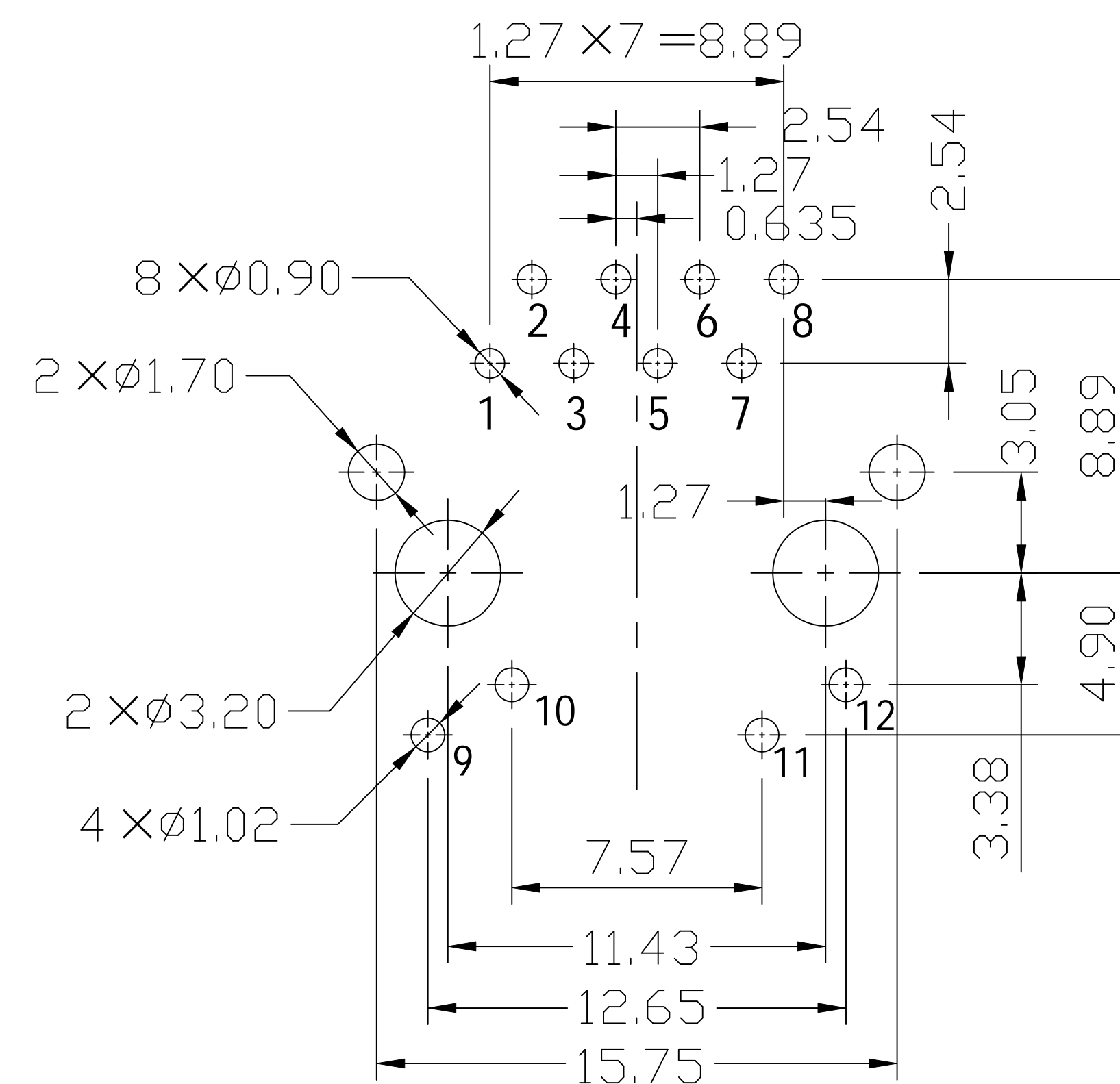

Suggested PCB Layout (Top View)

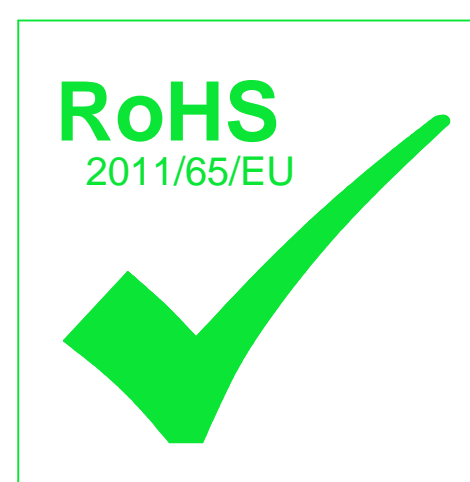

NOTES:

1. Designed to support application, such as SOHO (ADSL modems), LAN-on-Motherboard (LOM), hub and Switches.
2. Meets IEEE 802.3 specification
3. Connector Materials:
 Housing: Thermoplastic PBT+30%G.F UL94V-0
 Contact: Phosphor Bronze C5210R-EH Thickness=0.35mm
 Pins: Brass C2680R-H Thickness=0.35mm
 Shield: SUS 201-1/2H Thickness=0.2mm
 Contact plating: Gold 6 micro-inches min. In contact area.
4. Wave solder tip temperature: 265°C Max, 5 Sec.
5. UL Certification: File Number E484635.

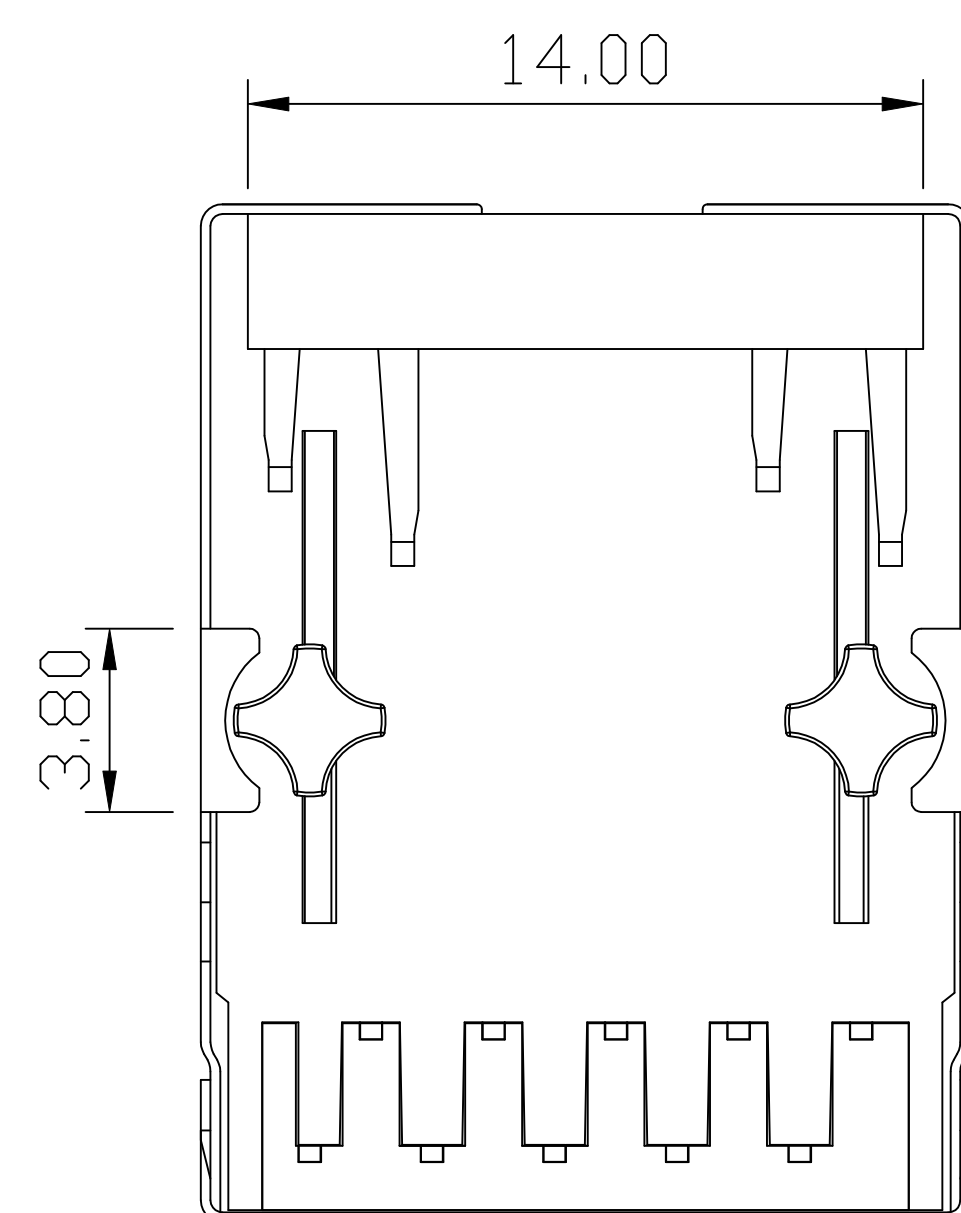

Bottom Side View

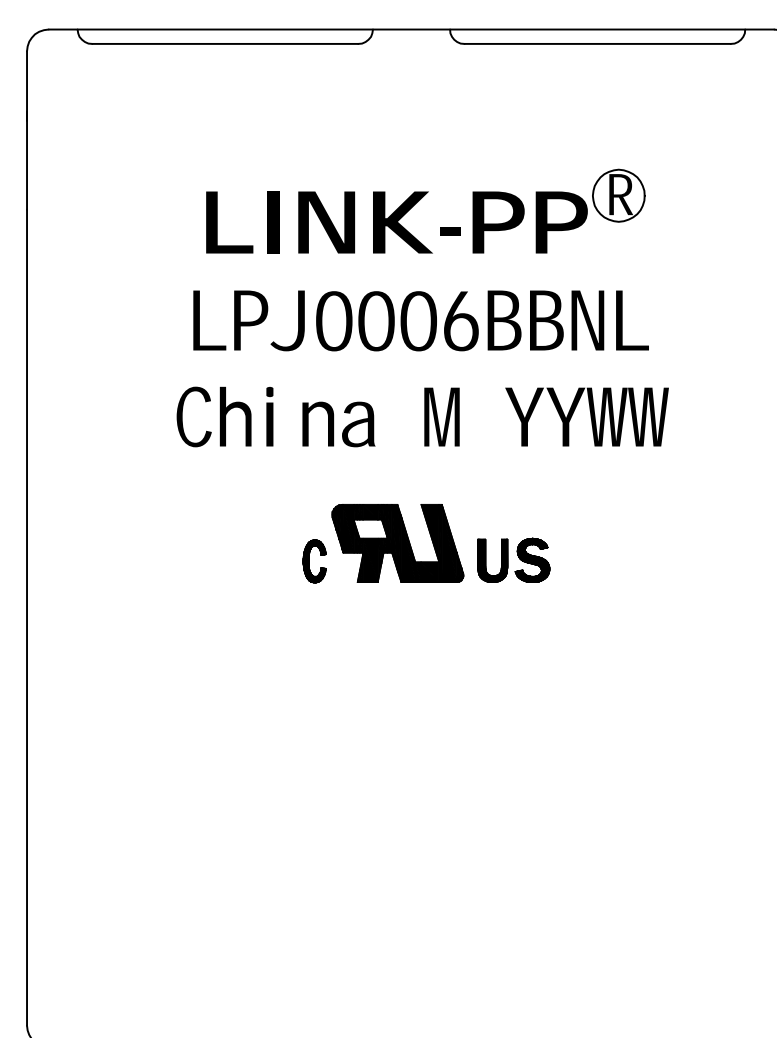

Top Side View

X: X ±0.30	APPD:	LINK-PP INT'L TECHNOLOGY CO., LIMITED
X: XX ±0.25	CHKD:	
X: XXX ±0.05	DR: TOM	TITLE: RJ45 Connector with 10/100 Base-T Integrated Magnetics
ANGLES ±1°	UNIT: mm	PART NO.: LPJ0006BBNL
	SCALE: 2/1	SHEET: 2/2
	REV: A	DWG NO.: LP08121246